

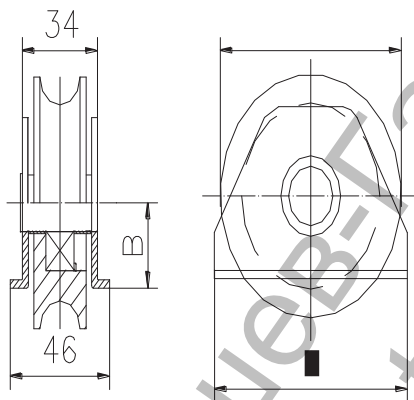

Ролка Estebro® за плъзгачи се врати на стойка ф 120x20 мм, неръждаема стомана 303, заваряване, U-20



Cod.	Medidas Dimensions	A	B	ØD			Peso Máx. Kg
419	80x20	80	27	78	12	8,40	655
439	90x20	95,5	31	88	12	11,65	655
440	100x20	95,5	31	98	10	12,05	655
441	120x20	115,5	41	118	6	11,45	655
<b>Familia 62   Acero Inoxidable - Inox - Stainless Steel</b>							<b>AISI 303 - 304</b>
684	80x20	86	25	78	4	3,11	655
685	100x20	106	35	98	4	5,60	655
686	120x20	126	45	118	2	4,16	655

**Family:** Wheels

**Material:** 11SMn30 steel, box: DD11 steel

**Finish:** Zinc-plated

**Maximum weight supported by the bearing\*:** 655 kg Description: Wheel with support and 6204 2RS bearing. It is installed in sliding doors to let their displacement over the guide. The installation consists in fitting the wheel into the door's base and fixing it by welding.

**\*In perfect conditions of installation, usage and maintenance.**

Продукт: [Ролка Estebro® за плъзгачи се врати на стойка ф 120x20 мм, неръждаема стомана 303, заваряване, U-20](#)

Категория: [Плъзгачи се врати](#)

Бранд: [Estebro®](#)

Категория бранд: [Ролка Estebro®](#)

Ташев-Галвинг ООД  
www.tashev-galving.com